

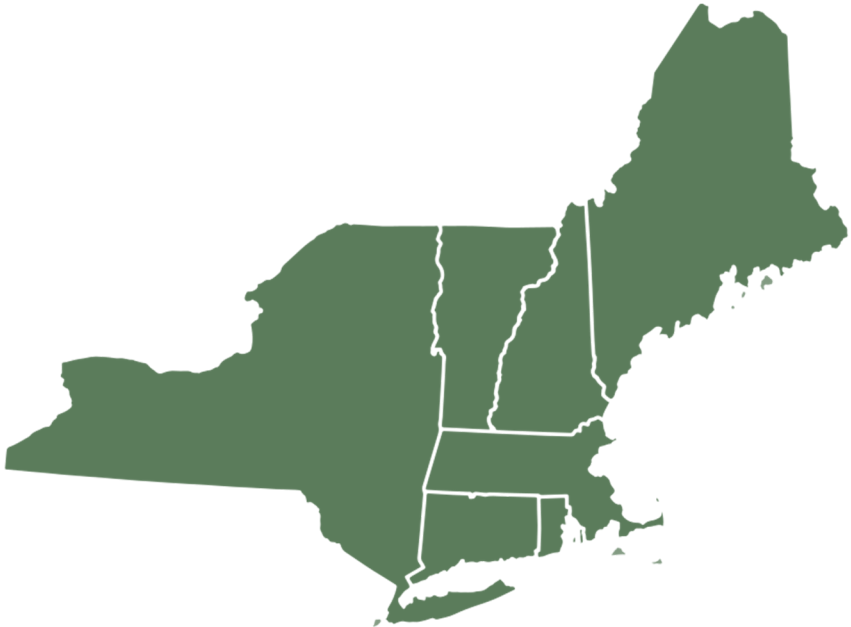

FEMC

Forest Ecosystem Monitoring Cooperative

Regional Forest Health Monitoring Field Guide



Last Updated: 03/21/2023

Table of Contents

Frequently Asked Questions.....	4
Quick Guide.....	6

General Plot Metrics

Plot Layout.....	7
Clustered	7
Nested.....	8

Tree Measurements

Tree Species Codes.....	9
Crown Class.....	12
Vigor	13
Crown Dieback	14
Live Crown Ratio	15
Tree Diameter Measurements.....	16
Foliage Transparency.....	18
Foliage Discoloration.....	19
Foliage Defoliation	19
Damage Codes	20

Microplot Measurements

Seedling measurements	23
Seedling and sapling measurements	24

Subplot Measurements

Browse Impact Ratings.....	25
Invasive Plants	26
Prism.....	28
Hemispherical Photography Methods.....	29

Field Tool Methods

Garmin GPS.....	30
Measuring Height	22
Haglof Hypsometer	32
Clinometer.....	33
Trimble	34

Table of Contents

Appendix

Special Damage Photos	36
Animal	36
Insect.....	38
Conks/Canker/Diseases	46
Weather.....	53
Seedling Photos	55
Conifer	55
Deciduous.....	57
Invasive Species Photos	62
Plot List & Coordinates	70
Vermont.....	70
Massachusetts.....	71

Frequently Asked Questions

Measuring DBH

Q: It seems clear from last year's data that the DBH of an unpainted tree was measured a few inches higher than 4.5 feet. Knowing this, I can measure the tree and get a DBH that matches last year's, or I can measure at 4.5 feet and record a DBH that is off from last year's measurement. Which is better?

Always pull a tape to measure up 4.5 feet on unpainted trees and measure DBH there (modified DBH should always be measured on the painted line). Even though it might be possible to recreate last year's DBH measurements by measuring the tree slightly differently, the tree should always be measured at 4.5 feet. The only exception to this rule is when a tree has a deformity at DBH (see DBH measurements section). *The same rule applies to measuring the DBH of saplings.* If you are still doubtful, take multiple DBHs, detailed notes and discuss it back at the office or give supervisor a call.

Measuring Tree Heights

Q: Sometimes it's challenging to see the top of a tree without being too close to the tree or standing either uphill or downhill. What are the most important considerations when measuring tree heights?

The most important thing when taking a tree measurement is that you are sure that you have a clear visual of the top of the tree in question. A clear line of sight is always the priority! Following that, try to minimize how uphill/downhill you are from the tree as this could distort your measurement of the tree's height. Also try to ensure that you are at least as far away from the tree as the tree is tall (ie if the tree is 30 meters tall, try to be 30 meters away from the tree when you take the measurement). A breakdown of the hierarchy of considerations is as follows:

- 1) Make sure you have a clear view of the tree top
- 2) Make sure you are at least that tree's height away from the tree in distance.
- 3) Make sure you are not standing uphill or downhill of the tree

The priority is always to view the top of the tree. The second priority is to try to follow the second and third considerations

Frequently Asked Questions

Q: After reviewing historical tree data, my current height measurements don't match up how can I walk away and be confident that I am taking the correct height?

1. Make sure that your tool is calibrated
2. Are you ensuring your positioning is correct. Your height is likely off because you are not seeing the top of the rounded top of the tree.
3. Use a clinometer to take a height for comparison
4. Take your measurement, ask your crew mates to take measurements and discuss. Either decide on a height or average your tree heights. Tree height measurements are calculated estimates. It is hard to be exact.

Seedlings and Microplot

Q: I found a bunch of seedlings that are definitely birches. I'm pretty sure that the seedlings are ironwood, since ironwood is the only birch that I can see nearby, but I'm not 100% certain. Is it better to try to identify the seedling to species with relative confidence or should I record the seedling as a generic birch?

It is always better to be less specific in your ID if you are not absolutely certain about the identity of a seedling. If you are not completely confident in an identification, document the seedling; you should have enough notes, photos, and pressed samples collected off the plot to bring back to the office for an expert to ID. When collecting samples make sure to give them labels so you can easily refer back to the documentation you took. Immediately send the information to your supervisor to get an accurate ID. Record the presence of the seedling using the most specific level of identification that you are 100% confident in. In the case of the example above, after documenting the seedling, record the seedling as a member of the birch family—code 370.

Dead Trees

Q: What data do we collect for vigor 5 (standing dead) trees?

For standing dead trees, measure the DBH of the tree and take its height. In the case that a dead tree becomes a risk to measure, make a note and skip it.

Quick Guide

Common species codes	
Common Name	FHM Code
American beech	531
American mountain-ash	935
balsam fir	12
black cherry	762
black oak	837
eastern hemlock	261
eastern white pine	129
gray birch	379
ironwood	701
mountain paper birch	376
northern red oak	833
paper birch	375
quaking aspen	746
red maple	316
red spruce	97
striped maple	315
sugar maple	318
sweet birch	372
white ash	541
yellow birch	371

Crown Class	
1	Open Grown
2	Dominant
3	Codominant
4	Intermediate
5	Suppressed/ overtopped

Tree Crown Vigor Codes	
1	Healthy
2	Light decline
3	Moderate decline
4	Severe decline
5	Dead & standing natu- ral caused
6	Dead & down, Human caused (cut)
7	Dead & standing, hu- man caused (girdle)
8	Dead and down, natu- ral
9	Missing

Defoliation/ Discoloration Classes	
0	None to trace defoliation/dicoloration
1	1 to 30 percent of crown defoliated/dicolorored
2	31 to 60 percent defoliation/dicoloration
3	More than 60 percent defoliation/dicoloration

Plot Layouts

Clustered Plot (VT/NH/RI)

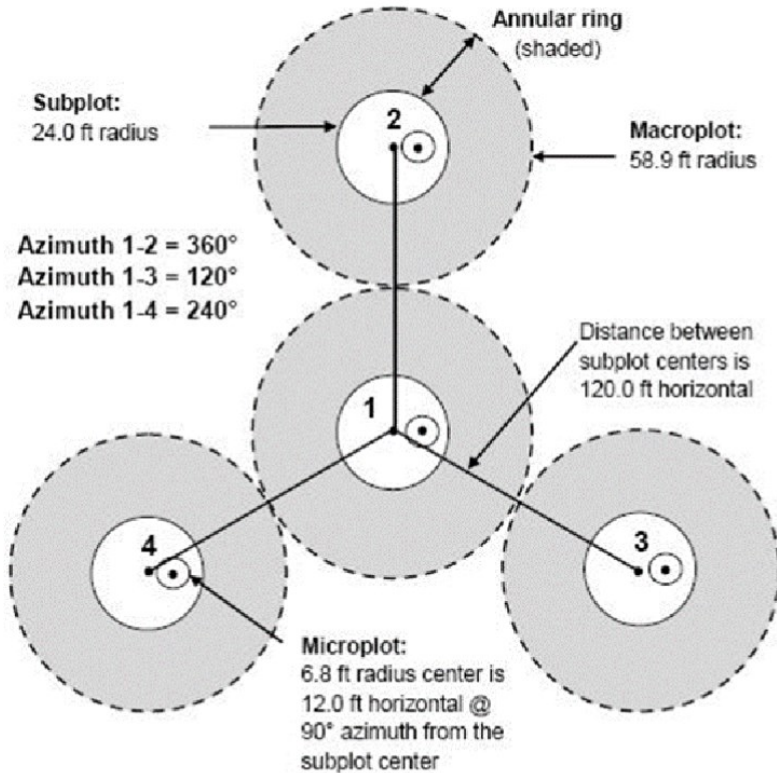

Cross Plot Navigation

Azimuths

Azimuth of 2-3 = 148°

Azimuth of 3-4 = 270°

Azimuth of 4-2 = 24°

Metric Conversions

24 ft	7.32 m
120 ft	36.57 m
12 ft	3.66 m
6.8 ft	2.07 m
5 in	12.7 cm

Plot Layouts

Nested (MA, CT, ME, NY)

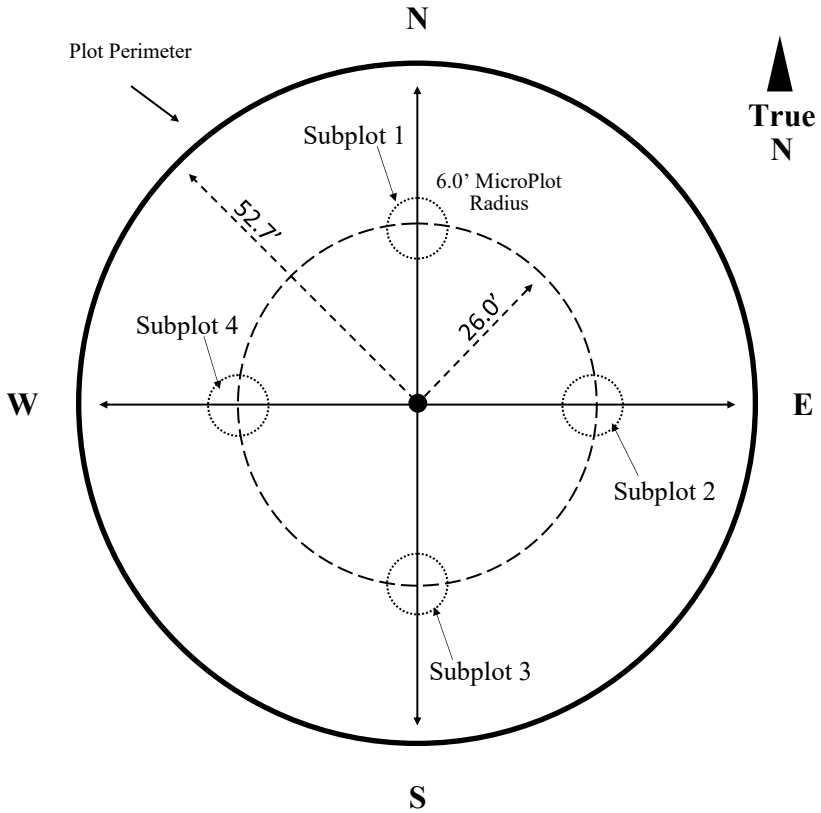

Metric Conversions		
Plot Radius	52.7'	16.06m
Micro-Plot Radius	6'	1.83m
Microplot to Plot Center	26.0'	7.92m

Tree Species Codes

Code	Abbreviation	Species
12	ABBA	balsam fir (<i>Abies balsamea</i>)
57	JU1	juniper; cedar (<i>Juniperus</i>)
68	JUVI	eastern red cedar (<i>Juniperus virginiana</i>)
71	LALA	eastern larch, tamarack (<i>Larix laricina</i>)
90	PI1	spruce (<i>Picea</i>)
91	PIAB	Norway spruce (<i>Picea abies</i>)
94	PIGL	white spruce (<i>Picea glauca</i>)
95	PIMA	black spruce (<i>Picea mariana</i>)
97	PIRU	red spruce (<i>Picea rubens</i>)
100	PI2	pine (<i>Pinus</i> sp.)
105	PIBA	Jack pine (<i>Pinus banksiana</i>)
125	PIRE	red pine (<i>Pinus resinosa</i>)
126	PIRI	pitch pine (<i>Pinus rigida</i>)
129	PIST	eastern white pine (<i>Pinus strobus</i>)
130	PISY	Scots pine (<i>Pinus sylvestris</i>)
241	THOC	arborvitae; northern white cedar (<i>Thuja occidentalis</i>)
261	TSCA	eastern hemlock (<i>Tsuga canadensis</i>)
310	AC	maples (<i>Acer</i>)
313	ACNE	boxelder (<i>Acer negundo</i>)
314	ACNI	black sugar maple (<i>Acer nigrum</i>)
315	ACPE	striped maple (<i>Acer pensylvanicum</i>)
316	ACRU	red maple (<i>Acer rubrum</i>)
317	ACSA1	silver maple (<i>Acer saccharinum</i>)
318	ACSA2	sugar maple (<i>Acer saccharum</i>)
319	ACSP	mountain maple (<i>Acer spicatum</i>)
320	ACPL	Norway maple (<i>Acer platanoides</i>)
350	AL	alnus spp. (<i>Alnus</i>)
355	ALGL	European alder (<i>Alnus glutinosa</i>)
356	AMSP	serviceberry (<i>Amelanchier</i> sp)
357	ALIN	Speckled Alder (<i>Alnus incana</i>)
370	BE	birch (<i>Betula</i>)
371	BEAL	yellow birch (<i>Betula alleghaniensis</i>)
372	BELE	sweet birch (<i>Betula lenta</i>)
375	BEPA	paper birch (<i>Betula papyrifera</i>)

Tree Species Codes

Code	Abbreviation	Species
376	BECO	mountain paper birch (<i>Betule cordifolia</i>)
379	BEPO	gray birch (<i>Betula populifolia</i>)
391	CACA	musclewood (<i>Carpinus caroliniana</i>)
400	CA	hickory spp (<i>Carya</i>)
402	CACO	bitternut hickory (<i>Carya cordiformis</i>)
403	CAGL	pignut hickory (<i>Carya glabra</i>)
407	CAOV	shagbark hickory (<i>Carya ovata</i>)
409	CATO	mockernut hickory (<i>Carya tomentosa</i>)
421	CADE	American chestnut (<i>Castanea dentata</i>)
531	FAGR	American beech (<i>Fagus grandifolia</i>)
540	FR	ash (<i>Fraxinus</i>)
541	FRAM	white ash (<i>Fraxinus americana</i>)
543	FRNI	black ash (<i>Fraxinus nigra</i>)
544	FRPE	green ash (<i>Fraxinus pennsylvanica</i>)
600	JU2	walnut (<i>Juglans</i>)
601	JUCI	butternut (<i>Juglans cinerea</i>)
602	JUNI	black walnut (<i>Juglans nigra</i>)
660	MA	apple (<i>Malus</i>)
693	NYSY	black tupelo, blackgum (<i>Nyssa sylvatica</i>)
701	OSVI	eastern hophornbeam; ironwood (<i>Ostrya virginiana</i>)
740	PO	cottonwood (<i>Populus</i>)
742	PODE	Eastern cottonwood (<i>Populus deltoides</i>)
743	POGR	bigtooth aspen (<i>Populus grandidentata</i>)
746	POTR	quaking aspen (<i>Populus tremuloides</i>)
760	PR	cherry, plum (<i>Prunus</i>)
761	PRPE	pin cherry (<i>Prunus pensylvanica</i>)
762	PRSE	black cherry (<i>Prunus serotina</i>)
763	PRVI	chokecherry (<i>Prunus virginiana</i>)

Tree Species Codes

Code	Abbreviation	Species
766	PRAM	American plum (<i>Prunus americana</i>)
800	QU	oak (<i>Quercus</i>)
802	QUAL	white oak (<i>Quercus alba</i>)
804	QUBI	swamp white oak (<i>Quercus bicolor</i>)
806	QUCO	scarlet oak (<i>Quercus coccinea</i>)
816	QUIL	bear oak (<i>Quercus ilicifolia</i>)
823	QUMA	bur oak (<i>Quercus macrocarpa</i>)
826	QUPR1	chinkapin oak (<i>Quercus prinoides</i>)
830	QUPA	pin oak (<i>Quercus palustris</i>)
832	QUPR2	chestnut oak (<i>Quercus prinus</i>)
833	QURU	northern red oak (<i>Quercus rubra</i>)
835	QUST	post oak (<i>Quercus stellata</i>)
837	QUVE	black oak (<i>Quercus velutina</i>)
901	ROPS	black locust (<i>Robinia pseudoacacia</i>)
920	SA	willow spp (<i>Salix</i>)
931	SAAL	sassafras (<i>Sassafras albidum</i>)
935	SOAM	American mountain-ash (<i>Sorbus americana</i>)
951	TIAM	American basswood (<i>Tilia americana</i>)
972	ULAM	American elm (<i>Ulmus americana</i>)
975	ULRU	slippery elm (<i>Ulmus rubra</i>)
977	ULTH	rock elm (<i>Ulmus thomasii</i>)
8421	PYCA80	Callery pear (<i>Pyrus calleryana</i>)
299	UNKS	Unknown softwood tree
998	UNKH	Unknown hardwood tree
999	UNKT	Unknown tree species

Crown Class

Crown Class Codes	
<i>The position of a tree's canopy in relation to surrounding tree crowns</i>	
1	Open Grown: Grown before rest of forest came up. May be different species or significantly larger than surrounding trees.
2	Dominant: Full sun on all sides of crown, taller than surrounding trees.
3	Codominant: Full top and maybe a few sides of crown receive full sun, sides shaded by surrounding trees, which are typically the same height.
4	Intermediate: Sides of canopy are shaded, as is a portion of the top. Surrounded by some taller trees .
5	Suppressed/overtopped: Fully shaded canopy, overtopped by surrounding trees.

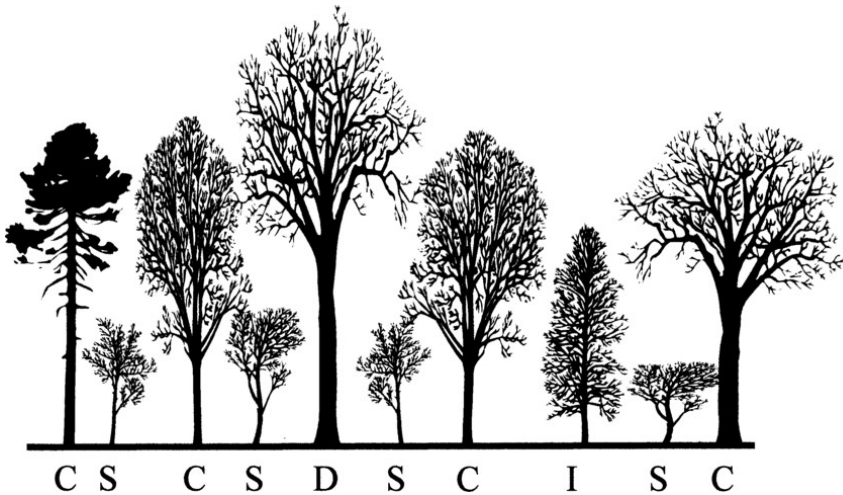
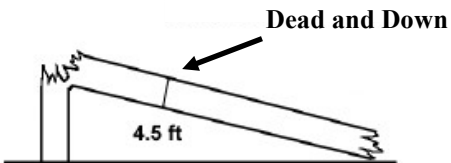
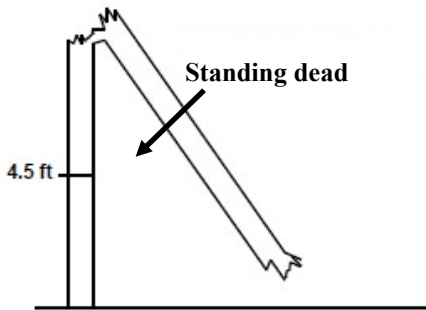
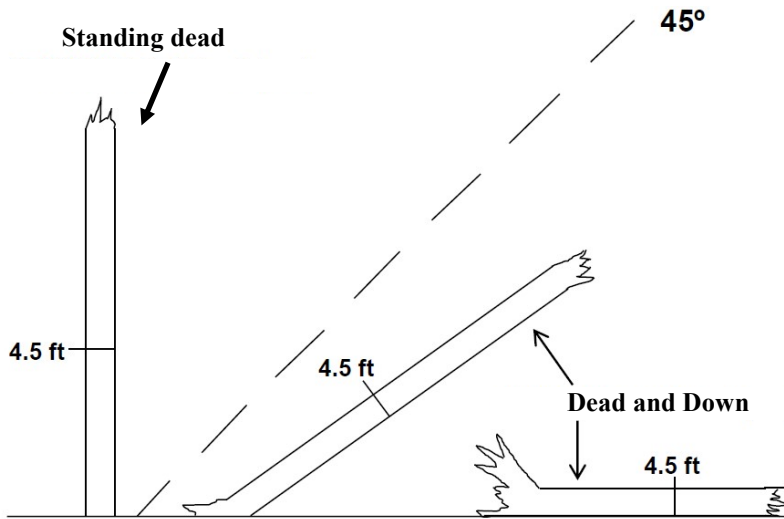

Diagram taken from Ward, Jeffrey & Anagnostakis, S. & Ferrandino, Francis. (2006). Stand dynamics in Connecticut hardwood forests: the old series plots (1927-1997).

Vigor

Tree Crown Vigor Codes	
<i>*vigor = large branch + fine twig mortality! (see dieback pg)</i>	
1	Healthy ; tree crown appears to be in reasonably good health; no major branch mortality; crown is reasonably normal; less than 10 percent branch or twig mortality.
2	Light decline ; branch mortality, twig dieback present in 10 to 25 percent of the crown; broken branches or crown area missing based on presence of old snags is less than 26 percent.
3	Moderate decline ; branch mortality, twig dieback in 26 to 50 percent of the crown; broken branches, or crown area missing based on presence of old snags is 50 percent or less.
4	Severe decline ; branch mortality, twig dieback present in more than 50 percent of the crown, but foliage is still present to indicate the tree is alive; broken branches, or crown area missing based on presence of old snags is more than 50 percent.
5	Dead and standing, natural caused ; tree is dead and still standing ; phloem under bark has brown streaks; few epicormic shoots may be present on the bole; record the dead tree's height and DBH.
6	Dead and down, human caused ; tree cut, or removed. Only record vigor/status
7	Dead and standing, human caused ; tree is standing dead and there are signs of human cause (i.e. girdled or damaged by equipment). Record DBH and height
8	Dead and down, natural caused : tree is dead and on the ground or a snag less than 4.5' (DBH). Only record vigor/status.
9	Missing : Tree cannot be located, Only record vigor/status.

*Note: To qualify as a standing dead tally tree, dead trees must be at least 1.0 inch in diameter, have a bole which has an unbroken ACTUAL LENGTH of at least 4.5 feet, and lean less than 45 degrees from vertical as measured from the base of the tree to 4.5 feet. If not, it is considered dead and down. See example on next page



Crown Dieback

Crown dieback reflects a tree's response to recent stress events. We estimate crown dieback as a percentage of the total live crown area that is occupied by fine twig dieback, rounded up into 5% classes.

To estimate: Project a 2-dimensional outline around the **live crown**, and determine the proportion of dead fine twigs to the whole live crown to get percent dieback.

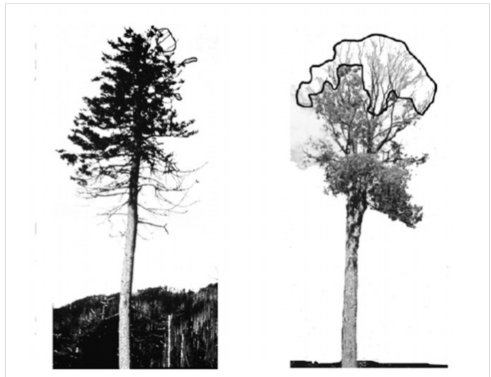

The whole tree canopy must be assessed from all angles! It is imperative that 2 or more individuals assess fine twig dieback from different angles of the tree and then discuss

their estimates. When two individuals disagree, they discuss, and move around the tree to view it from different angles until an agreement can be reached.

- **Lower and interior limbs are not included as dieback when dead twigs are due to natural pruning or self-shading.**
- **Important note:** Dieback does **not** include large branch mortality. However, **vigor** includes large branch mortality **and** twig dieback!
- *Vigor and dieback ratings are typically tied together. Make sure they make sense together! (i.e. dieback of 10-25% should have a vigor 2 rating or higher.)

Code	Definition	Code	Definition	Code	Definition
00	No Crown	35	31-35%	70	66-70%
05	1-5%	40	36-40%	75	71-75%
10	6-10%	45	41-45%	80	76-80%
15	11-15%	50	46-50%	85	81-85%
20	16-20%	55	51-55%	90	86-90%
25	21-25%	60	56-60%	95	91-95%
30	26-30%	65	61-65%	99	96-100%

Note: Class code is the percentage of the upper limits of the class, i.e., Code 10 is 6% to 10%, etc.

Live Crown Base

The live crown base is an imaginary horizontal line drawn across the trunk from the bottom of the lowest live foliage of the “obvious live crown.” The “obvious live crown” describes the continuous flow of foliage from the top of the crown extending downward to some point below which there is little to no foliage. Most crown branches/twigs are included, but epicormics, twig/sprigs, and straggler branches (more than 5 ft. (1.52 m) below the crown) that usually do not contribute much to the tree’s growth are excluded. The base of the live branch/twig bearing the lowest foliage may be above or below this line.

Determining Crown Base

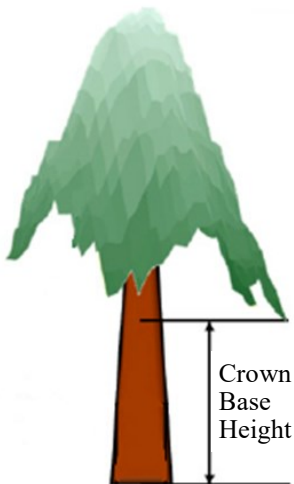

Five Foot Rule

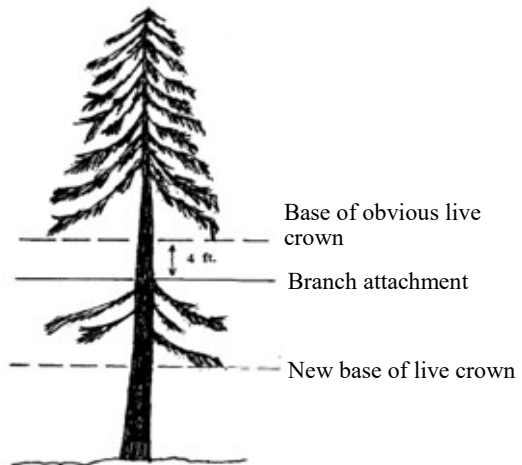

Five Foot Rule

If there are no gaps in the canopy, crown base is at the **lowest point of foliage** off the lowest branch that is at least **1” in diameter or greater** (branches that are smaller than 1” in diameter are **NOT** considered).

If there is a gap in the canopy that is LESS than 5 feet, consider branches below the gap, as long as the branches are 1” in diameter or greater

If there is a 5 foot or greater gap, crown base is at the top of the gap.

Tree Diameter Measurements

Tree diameter is measured at breast height (1.37 m/4.5 ft) on the **uphill side of each tree**. DBH must be 12.7 cm (5 inches) or greater in diameter to be a tree.

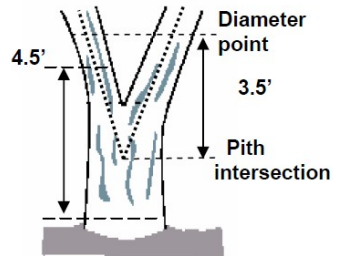

If the tree is **forked** (point where pith separates, represented as the point where the dotted lines separate in diagram 1) **below 30 cm (1 ft)**, consider each fork as a separate tree, and measure at 1.37 m.

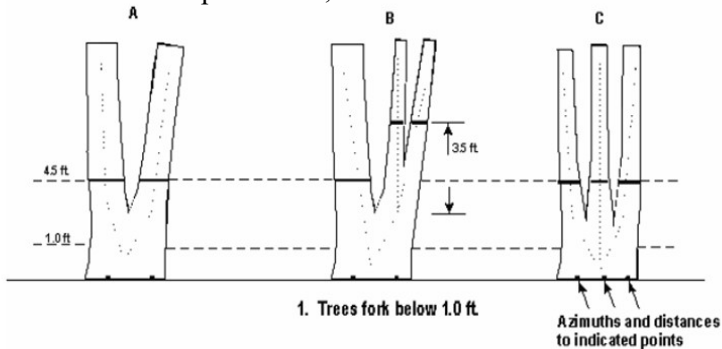

- If the tree forks **at or between 30 cm and 1.37 m**, measure the diameter 1 m (3.5 ft.) above the pith that joins the forks (where dotted lines meet in diagram 2).
- If the tree forks above 1.27m, it is considered one tree and measured at 1.37m.
- Record diameters in centimeters.

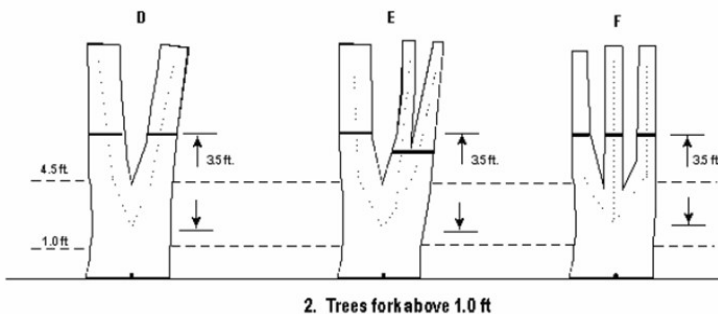

Tree Diameter Measurements

Trees will either have a painted line at DBH (**modified**) or will be unpainted (**traditional**). When measuring the DBH of an unpainted tree, measure up 4.5 feet off the ground (on the uphill side). If a tree is painted, measure DBH so that the bottom of the DBH tape is aligned with the top of the painted line (see photo below).



If there is a bulge at DBH, **measure just above the bulge**, where the bole returns to normal. Record the height at which you measured DBH on your form.

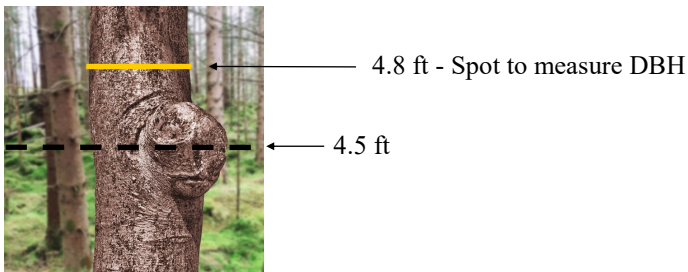

There are some unique cases in which a bulge may begin at or slightly below DBH and stretch upwards several feet, making it impossible to measure DBH above the bulge. If the bole returns to normal **slightly** below 4.5 feet, measure below the bulge and record the height of that measurement.

If there is a large crack or seam that extends the length of the bole and distorts the DBH, measure DBH at 4.5 feet and take photos to record the situation and take notes.

Down live tree with tree-form branches growing vertical from main bole: When a down live tree, touching the ground, has vertical (less than 45 degrees from vertical) tree-like branches coming off the main bole, first determine whether or not the pith of the main bole (averaged along the first log of the tree) is above or below the duff layer.

If the pith of the main bole is above the duff layer, use the same forking rules specified for a forked tree, and take all measurements accordingly (fig. 44).

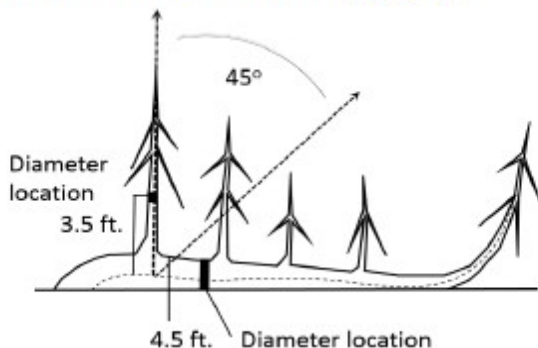

Figure 44. Down tree with pith above the duff.

If the pith intersection of the main down bole and vertical tree-like branch occurs below 4.5 feet from the stump along the main bole, treat that branch as a separate tree, and measure DBH 3.5 feet above the pith intersection for both the main bole and the tree-like branch.

If the intersection between the main down bole and the tree-like branch occurs beyond the 4.5 feet point from the stump along the main bole, treat that branch as part of the main down bole.

If the pith of main tree bole is below the duff layer, ignore the main bole, and treat each tree-like branch as a separate tree; take DBH and length measurements from the ground, not necessarily from the top of the down bole (fig. 45). However, if the top of the main tree bole curves out of the ground towards a vertical angle, treat that portion of that top as an individual tree originating where the pith leaves the duff layer.

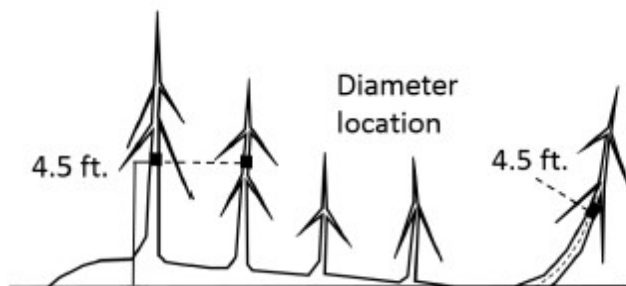

Figure 45. Down tree with pith below the duff.

Foliage Transparency

Foliage size and density are valuable indicators of the current health of trees.

Foliage transparency is a rating of the amount of skylight visible through the live, normally foliated portion of the crown, **excluding areas occupied by branches and large gaps between branches.**

Where branches (large and small) exist, rate the area as if light was penetrating those branches. A two-dimensional crown outline is projected around all living branches to estimate foliage transparency in 5% intervals.

Two certified raters are required to make the transparency estimates from opposite sides of the tree. When foliage transparency in one part of the crown differs from another part, an average foliage transparency is estimated.

It is important to check with binoculars to differentiate defoliated branches from dieback areas. Foliage on defoliated branches is included in transparency rating but branches are excluded from dieback (branch is not dead). A tree that is recently defoliated with only one or two leaves remaining would have a transparency rating of 99.

Foliage Transparency Scale

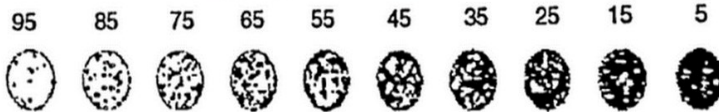

Foliage Discoloration & Defoliation

Defoliation is an estimate of leaf area reduction caused by a disturbance factor, such as insect, disease, or weather, and includes leaves with missing sections or missing leaves, with only the midvein remaining. Determine outline of live crown, and record percent of crown missing based on defoliation (see classes below). Dieback is NOT included in this estimate. **If defoliation exceeds 20%, also record a damage code 111 for that tree.**

Defoliation Classes	
0	None to trace defoliation
1	1 to 30 percent of crown defoliated
2	31 to 60 percent defoliation
3	More than 60 percent defoliation

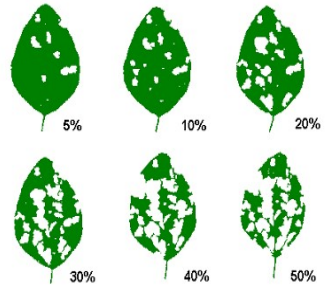

Discoloration recorded in 4 classes like defoliation. Look for off-color leaves that are more yellow, red, or brown than green. If off-color leaves are retained on a dead branch, they are NOT included in discoloration. Remember to make a note if you believe disco is related to fall foliage.

Discoloration Classes	
0	None to trace discolored
1	1 to 30 percent of crown discolored
2	31 to 60 percent discoloration
3	More than 60 percent discoloration



Damage Codes

Bole Damage Agent	FHM Code	FIA Damage Code	
Animal browse	441	---	<i>Animal Damage</i>
Beaver damage	444	41002	
Porcupine damage	445	41006	
Sapsucker damage	446	41008	
Other animal damage	447	41000	
Asian long-horned beetle	707	15082	<i>Borers and Insects</i>
Balsam woolly adelgid	101	14003	
Beech bark scale only	104	---	
Bruce spanworm	907	12120	
Defoliation > 20%	111	12000	
Eastern tent caterpillar	906	12093	
Emerald ash borer	711	15087	
Forest tent caterpillar	905	12096	
Gypsy moth	---	12089	
Hemlock woolly adelgid	103	14004	
Japanese cedar longhorn beetle	901	---	
Other bark beetles	110	11000	
Other borers	109	15000	
Pear thrip	909	14058	
Red pine scale	902	14033	
Saddled prominent	908	12079	
Sirex wood wasp	710	15090	
Southern pine beetle	107	11003	
Spotted lanternfly	903	---	
Spruce budworm	---	12038	
Sugar maple borer	108	15031	
White pine weevil	102	13029	
Winter moth	---	12197	

*FHM Codes should be used in VT and other states where FIA codes aren't applicable.

— = No code available

Damage Codes cont.

Bole Damage Agent	FHM Code	FIA Damage Code	
Beech bark disease	106	22042	<i>Cankers, Conks and Diseases</i>
Beech bark nectria only	105	—	
Beech leaf disease	<i>904</i>	—	
Butternut canker	201	22053	
Canker stain	—	22013	
Chestnut blight	—	22023	
Conks and other indicators of decay	208	22500	
Dutch elm disease	—	24022	
Dwarf mistletoe	209	23015	
European larch canker	206	22041	
Eutypella canker	203	22030	
Hypoxylon canker	204	22037	
Nectria canker	202	22043	
Oak wilt	—	24021	
Other canker	207	22000	
Parasitic/ epiphytic plants	—	23000	
Root/ butt diseases	—	21000	
Sudden oak death	—	21028	
Thousand cankers disease	—	22086	
White pine blister rust	210	26001	

***FHM Codes** should be used in VT and other states where FIA codes aren't applicable.

— = No code available

Damage Codes cont.

Bole Damage Agent	FHM Code	FIA Damage Code	
Cracks and seams	708	90007	<i>Weather-related</i>
Defoliation >20%	111	12000	
Discoloration >20%	—	90008	
Fire damage	—	30000	
Other weather damage	505	50000	
Wind-thrown/uprooted	501	50013	
Human-related			
Logging damage > 20% of circumference	702	70000	

***FHM Codes** should be used in VT and other states where FIA codes aren't applicable.

— = No code available

Microplot: Seedlings/Saplings

Always record measurements on the microplot **before** other subplot measurements to avoid any inadvertent trampling. Seedlings and saplings are recorded if the stem emerges from the ground within the radius of the microplot.

Seedlings

All established seedlings are tallied by species. This includes all established stems with a DBH **less than 1 in (2.54 cm)**. Established hardwood seedlings will have true leaves, not just cotyledons. Seedling species can be difficult to determine as leaf shapes can vary and differ from more mature plants. See [Appendix F](#) for photos and identification of common seedling species.

Seedlings are counted in two height classes, which are determined by whether the species is a conifer or a hardwood.

Seedling Type	Class 1	Class 2
Conifer	< 6 in (15 cm) tall	>= 6 in (15 cm) tall
Hardwood	< 12 in (30 cm) tall	>= 12 in (30 cm) tall

There are some seedlings that can be hard to record. Below are a few of the situations that are commonly encountered in the field.

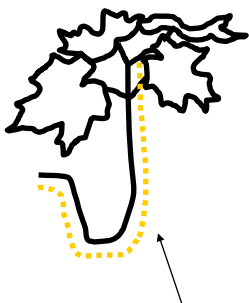

Measure this seedling along the stem, beginning where the seedling meets the soil and following the U all the way to the apical terminus of the seedling.

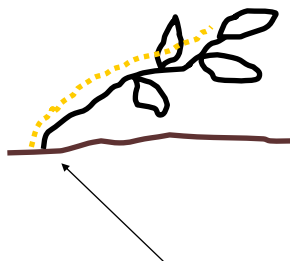

The height of a seedling is determined by the length of its stem, not its height off of the ground.

Microplot: Seedlings/Saplings

On occasion, multiple seedlings are found growing from the same root sprout. Gently sift through any duff that might surround the base of the sprouts and check to see that each stem emerges independently from the soil. Count each independently emerging stem as a individual seedling.

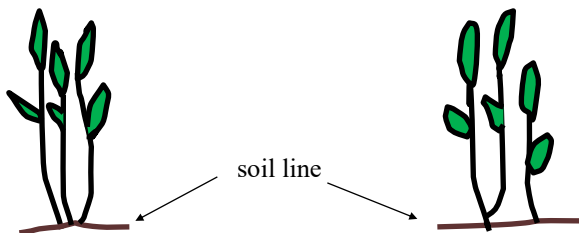

Each of these is counted as an individual seedling

There are only two seedlings above. Low branches can often be hidden by leaf litter.

Saplings

Saplings are between **1 in (2.54 cm) DBH to <5 in (12.7 cm)**. Record the **distance** and **azimuth** from the microplot center to the sapling, the **species**, **DBH**, and **status as living, dead, or other** refer to list. To avoid confusion with the trees on the larger subplot, **sapling ID numbers start at 100 for clustered (VT/NH/RI) and at (microplot#+000 for nested (MA/CT/ME/NY) plots (i.e. sapling 1 on microplot3 = sapling 3001).**

Sapling becomes a tree:

If an existing tallied sapling grows to 5 in (12.7 cm) DBH, it is recorded as a tree, with a new distance and magnetic (undeclined) azimuth measured from subplot center on the tree sheet. Record the DBH at the time the sapling becomes a tree on the sapling sheet for record keeping purposes and put status '7'. This DBH is not entered into the iPad or database. A sapling retains the same ID number when it moves to being a tree. If that treeID is taken, add 100 or 1000 to the sapling ID number and make note of change.

Sapling dies:

If a sapling is found to be dead or missing 5 years in a row, it is removed from the sapling list.

Saplings not present:

If no saplings are present in the microplot, circle "**Saplings Absent**" on data sheet.

Sapling Status

- 1 - Live
- 2 - Dead (DBH is measurable)
- 7* - Sapling grew into a tree
- 8*- Dead and down
- 9*- Sapling not surveyed/missing

* = Do not need to record DBH

Browse and animal damage

Record evidence of deer/moose browse on vegetation in each subplot as either **Present** or **Absent** and record an associated code.

Absent = Code: 2

Present = Code: 3, 4, or 5

Browse Impact: A code designating the amount of animal browse pressure exerted on the regeneration of the accessible forest area within the subplot (or 4 subplots for clustered plots). Pressure may be due to browse by deer, elk, feral hogs, livestock, moose, and other wildlife. This metric specifically refers to browse damage on woody plants within the plot.

Code	Description
2	Low impact - no browsing observed, vigorous seedlings present.
3	Medium impact- browsing evidence observed but not common, seedlings common
4	High impact- browsing evidence common OR seedlings are rare.
5	Very high impact- browsing evidence omnipresent OR forest floor bare, severe browse line.

A browse code of 1 refers to a site that is within a well-maintained, deer-free enclosure. No plots are within such an enclosure, so the scale begins at a code 2 Each plot should get an impact score.

Animal damage across the plot:

The most common animal damage you will likely see is ungulate (deer or moose) browse. If there is damage from any other type of animal other than an ungulate, circle **Present** under "other animal damage" on the field sheet and take a photo if possible. Make note of the type of animal that caused the damage if you can identify it.

**Note that "other animal damage" applies to damage of understory vegetation, seedlings, and saplings. Overstory trees have their own damage codes for animal damage.

Invasive Species Abundance Codes

Abundance Code	Description	Invasive Plant Density
1	Infrequent occurrence	1 to a few present
2	Sparsely throughout	1-2 plants together, in a few locations
3	Localized patches	Several plants together, occurring in a few locations
4	Frequent in stands	Dense areas of plants occurring in a few locations
5	Densely throughout	High populations making up understorey and/or regeneration

Invasive Species Codes

If an invasive species is unknown, a sample should be collected (preferably off the plot), photos should be taken with an object for size reference, and one of the following codes below should be recorded.

Once the unknown species is identified the unknown code should be updated to the correct species code.

Unknown Code	Common Name
2FERN	Fern or Fern Ally
2FORB	Forb (herbaceous, not grass nor grasslike)
2GRAM	Graminoid (grass or grasslike)
2PLANT	Plant
2SHRUB	Shrub (>.5m)
2SUBS	Subshrub (<.5m)
2TREE	Tree
2VH	Vine, herbaceous
2VW	Vine, woody

*If a species is found in VT and does not have a species code, use the NRCS Plant code. For other states use the NRCS plant code.

Invasive sp. Codes Continued

FHM Codes	NRCS Plants Code	Species Name	Latin Name
1	BETH	Barberry, Japanese and common	<i>Berberis thunbergii</i> , <i>B. vulgaris</i>
2	RHAMN	Buckthorn: common or glossy	<i>Rhamnus cathartica</i> , <i>R. frangula</i>
3	CEOR7	Bittersweet, oriental	<i>Celastrus orbiculatus</i>
4	LONIC	Honeysuckle: Bell, Japanese, Amur, Morrow or Tartarian	<i>Lonicera X bella</i> , <i>L. japonica</i> , <i>L. maackii</i> , <i>L. morrowii</i> , <i>L. tatarica</i>
5	ROMU	Multiflora Rose	<i>Rosa multiflora</i>
6	ACPL	Norway Maple	<i>Acer platanoides</i>
7	ELUM / ELAN	Autumn or Russian Olive	<i>Elaeagnus umbellate</i> , <i>E. angustifolia</i>
8	POCU6	Japanese knotweed	<i>Fallopia japonica</i> (<i>Polygonum cuspidatum</i>)
9	ALPE4	Garlic Mustard	<i>Alliaria petiolata</i> (<i>A. officinalis</i>)
10	LIVU	Privet	<i>Ligustrum vulgare</i>
11	AIAL	Tree of Heaven	<i>Ailanthus altissima</i>
12	ANSY	Wild Chervil (cow parsnip)	<i>Anthriscus sylvestris</i>
13	EUAL13	Burning Bush or winged Euonymus	<i>Euonymus alatus</i>
14	AEPO	Goutweed	<i>Aegopodium podagraria</i>
15	ACGI	Amur Maple	<i>Acer ginnala</i>
16	PHAM2	Amur cork-tree	<i>Phellodendron amurense</i>
17	CYLO11	Black swallow-wort	<i>Cynanchum louiseae</i>
18	LYNU	Creeping jenny, moneywort	<i>Lysimachia nummularia</i>
19	PUMO	Kudzu	<i>Pueraria montana</i>
20	POPE10	Mile-a-minute weed	<i>Polygonum perfoliatum</i>
21	CAIM	Narrowleaf bittercress	<i>Cardamine impatiens</i>
22	AMBR7	Porcelain berry	<i>Ampelopsis</i>
23	ACPS	Sycamore Maple	<i>Acer pseudoplatanus</i>
99	*	Other - please specify	

Prism

Record prism by standing with your arm outstretched and the **prism** held directly above plot center. Face due north (undeclinated) and rotate around the plot center clockwise, remembering to always have the prism **held directly above plot center as you rotate**. Point the prism at each tree so that it overlaps the bole at DBH. Some trees will fall firmly within the “in” category (see below); tally these trees. Some trees will be borderline; skip the first tree, then tally every other borderline tree. Do not tally any of the trees that are discernably out.

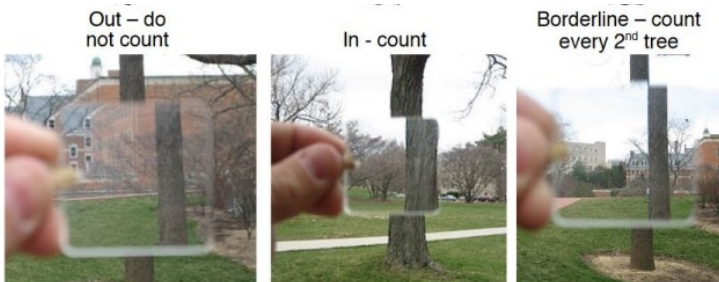

Important points to remember:

- **Hidden Trees:** Sometimes trees are hidden behind other trees from your vantage point at plot center. In these cases, move so that you can clearly see the bole of the hidden tree, ensuring that you remain at the same distance away from the tree if you were standing at plot center. (ie. If you are 5 feet away from the tree at plot center, ensure that you are still 5 feet away from tree when you look at the tree through the prism).
- **Saplings:** Remember that trees that are sapling sized but close to plot center can be technically in and counted for prism. Do not forget to look out for these smaller trees that are close to plot center!
- **Where to Measure:** Point the prism at the bole at DBH (4.5 feet up) when determining whether the tree is in or out.

Methods: Garmin GPS

Garmin Rino 530HCx

Marking a new location:

1. Turn on unit by holding down side power button for 3 seconds and letting go
2. Hit the screen selection button on the left side of the gps below the **TALK** button and navigate to the main menu.
3. From main menu, navigate over to the Mark option (person holding a flag as the symbol)
4. Rename the point—make sure name is unique and that the bearing and distance seem correct. If these values are very large, the GPS has not acquired enough satellites.

Enter in known coordinates to navigate to

1. If you are trying to navigate to a known coordinate, navigate down to the coordinates and enter the coordinates you are trying to navigate to (hit the screen selection button on the left side of the GPS below the TALK button and navigate to the main menu. Once at the main menu select Mark—person holding flag as symbol). ****Note that the longitude is not negative in this unit**
2. Click OK to enter your waypoint
3. If you are marking a new location and are currently in that location do not change the coordinates.
4. make sure to average the location to increase accuracy.
5. navigate down to the Avg option at the bottom left of the screen
6. go to Average Location and press enter
7. Wait until you have 100 measurement counts, the longer you can wait the more accurate the measurement will be.
8. Press Enter on Save to store the averaged coordinate location

Navigating to stored coordinates:

1. Make sure the unit is turned on
2. In the Main Menu navigate to Find
3. From FIND, navigate to Waypoints. ****If you do not see your plot, select the button to the right of the X - button at the top right corner. This will allow you to search by name.**
4. Select the point you would like to navigate to and press enter

Then you should see a screen with a bearing and distance...use your compass to see which direction to go and watch the distance magically decrease as you walk (if you are going in the right direction of course). If you don't see a screen with the bearing and distance, hit the NAV button to get a screen with that info. If you are getting nothing but an hourglass --- then the unit is still collecting satellite and you will need to wait or move to a position with better signal.

Methods: Garmin GPS

Garmin GPSTMap64ST

Checking battery status/backlight:

1. Quick press the power button
2. Continuing to quick press the power button will adjust the backlight settings

Entering new coordinates/markings a new location:

1. Turn on unit by holding down side power button for 3 seconds and letting go
2. Click the mark button
3. Use the navigation buttons to get to the title/name header at the top and click enter button
4. Rename the point
5. If you are trying to navigate to a known coordinate, navigate down to the location and enter your coordinates
6. Note that the longitude is not negative in this unit
7. Click done to enter your waypoint
8. If you are marking a new location and are currently in that location do not change the coordinates.
9. make sure to average the location to increase accuracy.
10. click the Menu button while in the Mark screen
11. go to Average Location and press enter
12. Press Enter on Start and then press Enter on Yes
13. Wait until the Sample Confidence is at 100%, the longer you can wait the more accurate the measurement will be.
14. Press Enter on Save to store the averaged coordinate location

Navigating to stored coordinates:

1. Make sure the unit is on
2. Click the Find button
3. If you are currently navigating to a point you will be prompted to find another point or to find another point or stop navigation
4. Navigate to Waypoints and choose the waypoint you would like to navigate to

Methods: Haglof Hypsometer

Each morning the hypsometer should be checked for proper settings and re-calibrated:

To turn on the transponder: Place the receiver against the transponder, press and hold the DME button until you hear two beeps.

To turn off the transponder: Place the receiver against the transponder, press and hold the DME button until you hear four beeps.

To turn on for heights and calibration: Press and hold the orange ON button.

To turn on for measuring distance: Press the DME button while unit is off.

To turn off: Press and hold DME and IR buttons simultaneously.

Required Settings

Press the **IR** right arrow button to SETUP then press the **ON** button (works as an enter command) and make sure that units are

METRIC; TYPE 2; P Offset 0.2; T HEIGHT 1.3; M DIST 0.0

If any of these are not true use the arrow buttons to change settings up or down.

Calibration

Once setup is complete, hit the **IR** button again to get to the CALIBRATE option.

Pre-measure a distance of exactly 10m and have one person standing with the transponder at the far end. Aim the instrument at the transponder (when in Calibrate mode) and press on. The instrument will automatically shut off when complete.

Measuring Distance

With instrument turned off, press the “DME” button to access the distance function. Place transponder on object and point instrument at it from plot center. Press the DME button to measure the distance.

Measuring Heights

Put instrument in Height mode (see above). Place the transponder at breast height on the tree of interest where there is a clear line of site to both the transponder and top of the tree. Look through the viewfinder and center the red cross on the transponder. Press and hold the orange on button until you hear a beep. The red cross should begin blinking. Center the cross on the point you want to measure the height of, and press and hold the orange on button again until it beeps. You can measure up to three heights and they will be saved on the instrument display.

****Make sure you are AT LEAST 50 FEET from the tree you are measuring!** Background sounds like rain and crickets can mess with the hypsometer, so make sure heights seem reasonable. If they do not seem right, use a clinometer.

Methods: Clinometer

1. You will start by standing 50 feet away from the tree you wish to measure. If you cannot see the tree from 50 feet, move back to 100 feet from the tree. **Use a measuring tape, do not eyeball the distance.**
2. Once you are positioned, hold the clinometer with the red dot pointing away from you. Look through the glass meter with one eye **and keep the other eye open**—noting that the glass meter contains a dial with two rows of measurements, a left hand scale (angle from horizontal) and a right hand scale (percent slope).
3. Now, look towards the tree. Level out the clinometer so both scales read zero.
4. Point the clinometer towards the top of the tree and record **the number from the right-hand scale** that corresponds to your line of sight.
5. Without moving your head, tilt the clinometer down to the base of the tree while keeping the glass eyepiece steady at the same point from where you took the top reading. Record the number **from the right-hand scale** that corresponds with your line of sight to the bottom of the tree.
6. Add these numbers together (ignoring the negative sign).
7. If you took this measurement **50 feet away, divide your answer from step 6 by 2**. If you took the measurement 100 feet away, **do not** divide your answer from number 6 by 2.

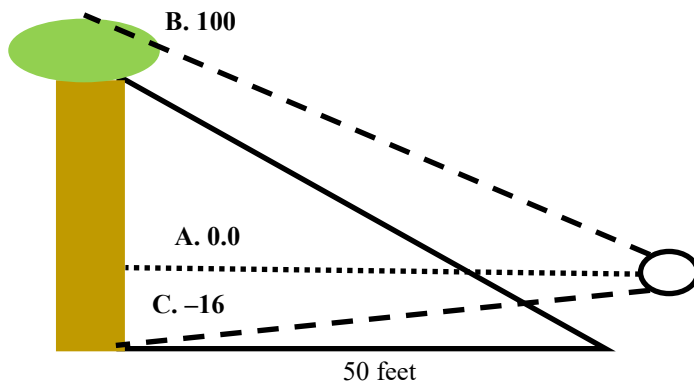

- A. Level clinometer so both scales read 0
- B. Record number on right-hand scale looking at top of tree (in this example 100)
- C. Record number on right-hand scale looking at bottom of tree (-16 here).
- D. Subtract C from B getting 116 here ($100 - 16 = 116$)
- E. Divide by 2 (you're 50' away here) getting 58' as height.

Equation for varying distances from tree:

Clinometer Tree Height = (Clinometer reading top - Clinometer reading bottom) / 100 x Distance from Tree

Methods: Trimble (1)

1. From initial start menu, click the Windows icon in top-left of screen and open **TerraSync**
 - a. Initial screen will show the “**Skyplot**” under the **Status** options, which depicts satellite coverage

Initial Setup

2. Click on **Status** and navigate to the **Setup** options
 - a. Under “**Coordinate System**” ensure you are collecting data with the following settings, then click OK:
SYSTEM: **UTM**
ZONE: **18 North**
DATUM: **WGS 1984**
ALTITUDE REFERENCE: **Height Above Ellipsoid (HAE)**
ALTITUDE and COORDINATE UNITS: **Meters**
 - b. Under “**GPS Settings**” ensure that the Productivity-Precision slider is set all the way to the Productivity end (left), then click OK – this tells the system to log data even when satellite reception is relatively poor and thus locational accuracy isn’t very precise (can be fixed via post-processing)
 - c. Under “**Units**” ensure the Lat/Long format is set to **DD.ddd°** (decimal degrees), then click OK
 - d. Under “**Logging Settings**” ensure antenna height is set to 2 meters (NOTE: this is the height you want to be holding either the Trimble unit or external antenna at – see below – when logging locational data)
 - i. If using the external antenna, ensure **Type** is set to “**Hurricane**” with **Part Number: 50393-50**
 - ii. If using just the Trimble unit, ensure **Type** is set to “**GeoXH 2008 Internal**”

Creating a New Data File (Point) and Logging Location

3. Click on **Setup** and navigate to the **Data** options
 - a. Ensure you’re in the “**New**” tab and that the default settings show:
File Type: Rover
Location: Default
Dictionary Name: Generic
 - b. Rename the **File Name** based on the plot and subplot you are at (e.g. VMC345-1 for subplot 1 in plot VMC345)
 - c. Click **Create** in the upper-right of the screen
A prompt will show the antenna **height** (2 m) and **measure to** (bottom of receiver), click OK – **note the unit will assume these settings when logging locational data**
 - d. Ensure the “**Point_generic**” option is highlighted, then click the **Create** button with the blue circle in the upper-right

Methods: Trimble (2)

- e. A **red target** now appears in the upper-right with a number next to it – this is the number of satellite “hits” the unit is logging at the point you’ve created
- f. Add any comments about the plot in the **Comment** box if needed
- g. **Let the unit log at least 100 points before clicking the OK button with the red stop square**
- h. Click Ok to confirm you want to close the feature: 1 Point generic
- i. **Click Close in the upper right to ensure the data file is closed**
- j. You can check that you’ve successfully created the data file/point by clicking on the “**Existing File**” tab (still under the **Data** options)
- i. The data file you just created should be at the top of the file list, with the number of positions displayed in the bottom right (e.g. **Positions: 103**). In the bottom left, it should say **Status: Not Transferred** as the file has not yet been downloaded from the unit.
- k. If you made a mistake naming the file, or simply want to delete a file, you can click on the **File Manager** tab, then in the upper right click **Options, then Delete**—**NOTE:** be careful when deleting files that have not been transferred, as **they cannot be reclaimed!**
- i. To rename a file click **Rename**

Shutting Down the Trimble

4. Once you’ve collected the point data and are ready to turn off the Trimble, **ensure that:**
 - a. **The data file is closed**
 - b. **That you’ve exited out of TerraSync**

IMPORTANT: Failure to close data files and/or exit out of TerraSync can corrupt the file data/system, which will result in lost data and wasted time/effort!

*Trouble Shooting Problems: 1) Press reset button near windows symbol 2) if step 1 doesn’t work do a hard reset, hold green button and then press reset button 3) if 2 doesn’t work, hold the green button for 60 seconds, **WARNING: Device will be wiped, all information erased if you perform step 3.**

Animal Damages: Photos



Animal Browse—441

Hosts: Any species bark & twigs
Description: Missing twigs, multiple stemmed regeneration; torn bark with teeth marks.



Beaver damage— 444

Hosts: Hardwoods found close to water.
Description: Lower bole with wedge-shaped feeding.



Porcupine damage— 445

Hosts: Bark and twigs of many species, notably eastern hemlock.
Description: Upper bole with bark missing and obvious feeding.

Animal Damages: Photos



Sapsucker damage– 446

Hosts: Many species.
Description: Rows of small holes which can surround part of nearly all of tree stem.



Other animal damage– 447

Hosts: Any species.
Description: Bark removed from horn/antler rubbings.

Insect Damages: Photos



Asian long horned beetle– 707

Hosts: Many hardwoods
Description: Bark scars at oviposition sites; circular exit holes; insect is large (ca. 1 inch), black with white spots, but no spot where thorax intersects wings, and long antennae.



Balsam woolly adelgid– 101

Hosts: Balsam fir
Description: Damage symptoms includes gouting, swellings around buds and branch nodes. Insect is tiny, covered with white wool fibers, usually grouped at bark lenticels or around branch and twig nodes.



Beech bark scale only– 104

Hosts: American beech.
Description: Tiny insects that excrete a white, woolly wax that covers their bodies.

Insect Damages: Photos



Bruce Spanworm– 12120

Hosts: maples and poplars also occurs on willow, beech, white birch, red oak, pine and choke cherries

Description: Defoliates from May to late June. Green “inchworm”. Can severely defoliate trees.



Defoliation > 20% - 111

Hosts: Any species.

Description: Feeding or loss of leaves or needles that affects more than 20% of the crown.



Eastern Tent Caterpillar– 12093

Hosts: wild cherry, apple, crabapple, but may be found on hawthorn, maple, cherry, peach, pear and plum

Description: Forms tents in crotches of tree branches, defoliates trees during June and July.



Insect Damages: Photos



**Emerald ash borer—
711**

Hosts: All ash species.
Description: Most obvious symptom is bark blanding, woodpecker activity resulting in bark removal. Small emerald colored beetle emerges from wood in early June. Exit holes are “D”-shaped.



**Forest Tent Caterpillar—
12096**

Hosts: Sugar maple, red oak, will defoliate other hardwoods.
Description: egg masses surround twigs. Look for defoliation in June and July. Will congregate in masses on bole of tree, do not spin tents.



Gypsy moth—12089

Host: oak, crabapple, linden, poplar, beech, willow, birch, sweetgum, serviceberry, and hawthorn. Oak in particular
Description: Hairy, quarter sized egg masses. Caterpillars are hairy, with 5 blue dot pairs, followed by 6 red dot pairs. Yellow head. Defoliates trees aggressively.

Insect Damages: Photos



Hemlock woolly adelgid– 103

Hosts: Eastern hemlock.
Description: Small white fluffy masses covering wingless insects found at base of needles. Discoloration typically prevalent.



Japanese cedar long-horn beetle—901

Hosts: Cupressaceae, occasionally Pinaceae
Description: Attacks dead/dying plants typically, sometimes goes for healthy individuals. Chewed/ puckered bark on smaller branches/ stems, 6-10 mm exit hole.



Other bark beetles– 110

Hosts: Any species.
Description: Exit holes

Insect Damages: Photos



Other borers– 109

Hosts: Any species.
Description: Symptoms include exit holes and galleries.



Pear thrip– 14058

Hosts: Sugar maple, along with beech, cherry, birch, ash, other fruit trees.
Description: deformed, discolored leaves, thin crown,



Red pine scale —14033

Hosts: red pine
Description: tiny invasive insect, kills red pines. Foliage discoloration and fuzzy, white cottony sacks on stem and branches.

Insect Damages: Photos



**Saddled prominent—
12079**

Hosts: Beech and sugar maple are preferred, oak and birch as well
Description: defoliates trees from July through early August. Eggs laid on leaves and feeds on leaves.



Sirex wood wasp— 710

Hosts: Pine species, commonly scots pine.
Description: Small exit holes especially on Scotts Pine boles.



**Southern pine beetle—
11003**

Host: Red, pitch, jack pine
Description: Discolored foliage, sawdust at base of tree, pitch tubes (resin masses), pitch runs, 1mm round exit holes, s-shaped galleries in sapwood.



Insect Damages: Photos

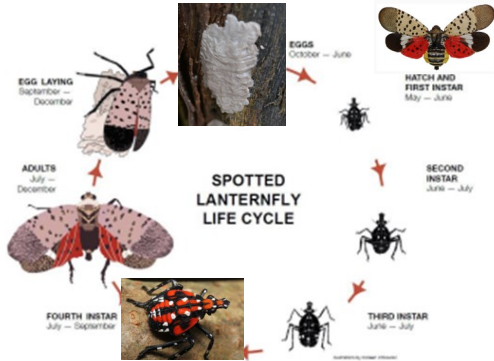

Spotted lanternfly - 903

Hosts: Rosaceae, maples, walnuts, tulip
 Description: Feeds on sap from stems, leaves, trunks. Look for small red or black nymphs with white spots, adult moths, or egg masses (gray “putty-like”)



Spruce budworm— 12038

Host: Balsam fir, white spruce. Occasionally other spruces, larch, hemlock, pine
 Description: defoliation on branch tips, starting at top of tree. Silk from worms and discoloration may also occur. Caterpillars and moths are brown.



Sugar maple borer– 108

Hosts: Sugar maple
 Description: insect bores diagonally below bark surface leaving a distinct line, but sometimes a sunken area with bark covering.

Insect Damages: Photos



White pine weevil– 102

Hosts: White pine; sometimes other pines and spruce species.
Description: Insect feeding kills leader; results in trees with multiple stems or irregular shaped stem.



Winter moth—12197

Hosts: Quercus, Rosaceae, Acer, Ulnus, Tilia
Description: Caterpillars are green “inchworm” with white stripe. Drop to the ground and pupate by mid-June. Moths are brown and fuzzy-looking.

Canker/Conk/Disease Damages: Photos



Both beech scale and nectria– 106

Hosts: American beech.
Description: Diseased trees with craterlike scars.



Beech bark nectria only– 105

Hosts: American beech.
Description: Tarry spot from nectria infection; other symptoms include reddish fruiting bodies (perithecia)



Beech leaf disease - 904

Hosts: Beech trees.
Description: Dark green bands between leaf veins. Leaves become curled and leathery. Aborted bud development and reduced leaf production follow, eventually kills tree.

Canker/Conk/Disease Damages: Photos



Butternut canker— 201

Hosts: Butternut.
Description: Sunken bark, oozing brown wounds with internal decay.

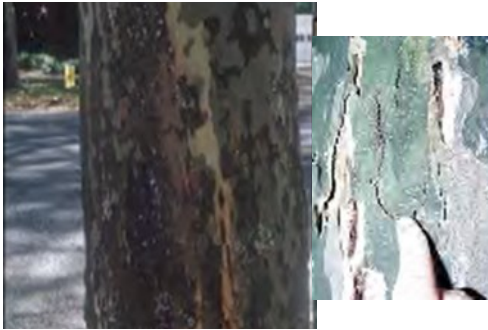

Canker stain—22013

Hosts: sycamore sp.
Description: Dieback, thin foliage, wilted leaves. Long sunken cankers, dark brown to black in color.



Chestnut blight—22023

Hosts: chestnut sp.
Description: Blackened, cracking bark on large stems. Cankers on small stems/ branches are yellow to reddish. Fruiting bodies are small and yellow-orange.

Canker/Conk/Disease Damages: Photos



Conks— 208

Hosts: Any species.
Description: Fruiting bodies indicating internal decay on the main bole or crownstem.



Dutch elm disease—24022

Hosts: elm sp.
Description: Wilted outer leaves, brown streaking of sapwood when outer bark is removed.



Dwarf mistletoe-209

Hosts: Primarily black spruce, occasionally other spruces and larch.
Description: Dense clustering of twigs or branches arising from a common point.

Canker/Conk/Disease Damages: Photos



European larch canker– 206

Hosts: All larch (tamarack) species.
Description: Bulging stem with black, resin exudate.



Eutypella canker– 203

Hosts: Maple species, including box elder.
Description: Ugly, irregular shaped bulge on bole with wood exposed in non-uniform pattern.



Hypoxylon canker– 204

Hosts: Quaking aspen and other poplars.
Description: Young cankers appear as sunken bark with yellowish-orange areas. Older cankers become blistered with blackened center.

Canker/Conk/Disease Damages: Photos



Nectria canker— 202

Hosts: Many hardwoods
Description: Target shaped open wound still actively expanding at outer rim.



Oak Wilt—24021

Hosts: Primarily red oak group, can attack any oak though.
Description: Leaves start wilting/ browning from margin in, fall prematurely. Dieback at top of tree. Fungal mat can crack bark .



Other canker— 207

Hosts: Any species.
Description: Obvious mycelium conks.

Canker/Conk/Disease Damages: Photos

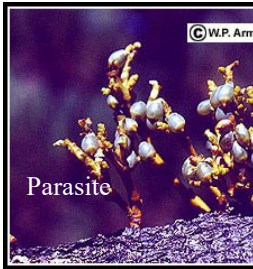

Parasitic/ epiphytic plants - 23000

Host: Any species

Description: Parasitic plants are rooted directly into the host tree and steal nutrients from them (from roots, bole, branches etc.). Epiphytic plants hang on or grow from their hosts but obtain their own nutrients (like vines).



Root/ Butt Rot Diseases - 21000

Host: Any species

Description: root (roots of tree) and butt (base of tree) rots are caused by many different species of fungi and can affect any tree species. Usually old or damaged trees are the ones affected. Look for dieback, stains, and fruiting bodies coming out of the roots or base of tree.



Sudden oak death - 21028

Hosts: Mature red oak and live oak groups

Description: Fungal infection. Large stains/ some cankers on infected stems. Leaves turn brown in a few weeks, and tree dies quickly after this happens. Usually trees are infected in groups. Not reported in the eastern US yet.

Canker/Conk/Disease Damages: Photos

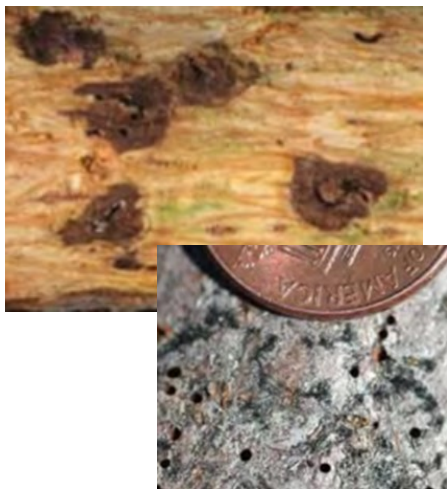

Thousand cankers disease - 22086

Hosts: walnut sp.
Description: pest complex: walnut twig beetle and fungus. Branch mortality, foliage discoloration, numerous small, circular cankers, staining, cracks. Tiny insect exit holes.



White pine blister rust– 210

Hosts: Pine species
Description: Symptoms vary with disease stage including red needled branch flag, depressed branch cankers with color contrast, and resin exudate from bole.

Weather Damages: Photos



Cracks and seams – 708

Hosts: Any species.

Description: Vertical separations that break out to the surface often called frost cracks >5 feet in length. Seams develop as the tree attempts to heal. Only account for this year's damage



**Discoloration >20%
- 90008**

Hosts: Any species.

Description: Yellow, brown, black, red coloration on leaves. Make sure this is not confused with fall foliage change!



Fire damage - 30000

Hosts: Any species.

Description: Blackened bark, charcoal on tree/ around tree

Weather Damages: Photos



Other weather damage– 505

Hosts: Any species.
Description: Ice, snow, or wind damage such as broken branches, broken or bent boles; drought symptoms such as brown foliage or early color.



Wind-thrown/uprooted– 501

Hosts: Any species. “Fir waves” common.
Description: Roots torn from ground along with trunk.



Logging damage > 20% of circumference– 702

Hosts: Any species.
Description: An opening or series of openings where bark has been removed exposing inner wood. Usually on lower bole, but occasionally higher.

Seedlings: Conifers



Black Spruce

Roundish needles sharp and stiff to the touch, spirally arranged around shoot, appearing to spread in all directions. Dark rusty-greyish pubescence on the twigs. Shortest needles (0.5-1.5cm) of the spruces, appearing incurved. Needles exude a menthol odor when crushed. Grows in extremely wet, boggy habitat.
Similar Species: Red Spruce, White Spruce



White Spruce

Roundish needles sharp and stiff to the touch, spirally arranged around shoot, appearing crowded on upper side of branch due to twisting of bottom needles. Lacking pubescence on the twigs. Dark bluish-green needles that exude a disagreeable odor when crushed (“skunk spruce”). Grows in riparian and alluvial soils and edges of bogs.
Similar Species: Red Spruce, Black Spruce



White Pine

Needles bundled in clusters of 5, long (7-12cm), slender, straight, soft and flexible. **Red pine similar but with needles in bundles of 2 (not shown).**

Similar Species: Red Pine (not shown—see above)

Seedlings: Conifers



Eastern Hemlock

Flattened needles that are soft and flexible, glossy green above and paler green below; 2 white lines on the underside along the midrib. Needles spiraled around shoot, but appearing two-ranked due to twisting of the petiole. Shorter, smaller needles than Balsam fir without the resinous, “Christmas tree” scent when crushed.

Similar Species: Balsam Fir



Balsam Fir

Flattened needles with white lines underneath, sessile (attached directly to stem) with disc-like appearance where needle meets stem. Longer, larger needles than hemlock, with distinct resinous “Christmas tree” scent when crushed. Needles spiral around shoot, though sometimes appearing two-ranked.

Similar species: Eastern Hemlock



Red Spruce

Roundish needles sharp and stiff to the touch, spirally arranged, appearing to spread in all directions. Reddish pubescence on the twigs, sometimes whitish pubescence when young. Raised, bumpy appearance where needles attach. Needles exude an orange rind odor when crushed. Generally found in upland/high elevation environments.

Similar Species: Black Spruce, White Spruce

Seedlings: Deciduous



Mountain Maple

Simple, opposite leaves with 3 very shallow lobes. Leaves coarsely and irregularly serrate, larger teeth than Striped Maple. Soft, whitish pubescence on the underside of the leaf.

Similar Species: Sugar Maple, Red Maple, Striped Maple



American Beech

Simple, alternate leaves oblong and acuminate (tapering to a point) with coarse teeth regularly-spaced. Leaf veins terminate at each tooth on the leaf margin. American Elm is doubly-serrate with a rough leaf texture on the upper-side. Similar Species: American Elm



Yellow Birch

Simple, alternate leaves oval, apex acuminate (tapering to a point) with coarse teeth regularly-spaced. Leaves sharply doubly-serrate with short petioles. Twigs and buds have a wintergreen flavor/odor when chewed/crushed. Often grow on decaying logs, stumps, and moss, also mineral-rich soil.

Seedlings: Deciduous



White Ash

Pinnately compound, opposite leaves usually 7-9 per leaflet. Leaves entire or obscurely serrate near tip, usually with small bumps on the underside (papillose). Stout, grooved petioles.

Similar Species: Mountain Ash , Shagbark Hickory



Mountain Ash

Pinnately compound, alternate leaves usually 9-17 per leaflet, 3-4x as long as broad. Leaves sessile or nearly so except for the terminal leaf, finely or sharply serrate above the entire base. Stout, grooved petioles.

Similar Species: White Ash, Shagbark Hickory



Shagbark Hickory

Pinnately compound, alternate leaves almost always 5 per leaflet, terminal leaf almost always larger than the lateral. Leaves finely serrate and fringed with minute, dense tufts of white hair upon most of the serrations in full sunlight. Fragrant when crushed. Similar Species: White Ash, Mountain Ash

Seedlings: Deciduous



Sugar Maple

Simple, opposite leaves, usually 5-lobed but sometimes 3-lobed when young; lobes sparingly wavy-toothed with broad sinuses that are rounded at the base. Lobes lacking serrate margins exhibited by the similar species listed below.

Similar Species: Red Maple, Striped Maple, Mountain



Red Maple

Simple, opposite leaves, usually 3-lobed but sometimes 5-lobed when young; lobes similar to Sugar Maple, but with many serrations around the margins. Leaves typically whitish and glabrous on the underside. Distinguished from Striped and Mountain Maple by deep sinuses similar to Sugar Maple.

Similar Species: Sugar Maple, Striped Maple, Mountain



Striped Maple

Simple, opposite leaves, 3 shallow lobes above the middle that taper at the end. End lobe broadly triangular. Leaves finely and sharply doubly-serrate, usually with 3 prominent, palmate veins. Distinguished from Mountain Maple by tapering lobes and finer/double serrations on the leaf margins.

Similar Species: Sugar Maple,

Seedlings: Deciduous



Basswood

Simple, alternate, heart-shaped leaves, typically with uneven base. Seedlings exhibit unique palmately-lobed cotyledons. This feature distinguishes Basswood from Hobblebush (not shown). Hobblebush also has opposite leaves in pairs, with rust-colored hairs on the undersides and prominent veins. Similar Species: Hobblebush (not shown—see above)



Quaking Aspen

Simple, alternate leaves, broadly ovate to nearly round, dark green and lustrous (shiny) above, paler below. Long petiole, often longer than the leaf, that is flattened so that the leaves appear to quake/tremble in the slightest breeze. Finely serrate with somewhat rounded teeth. Similar Species: Bigtooth Aspen (Not shown)



Red Oak

Simple, alternate leaves, 5-11 lobed with coarse-toothed, bristle-tipped lobes tapering from broad bases and round, oblique, rounded sinuses. Younger leaves without deep sinuses, but still coarsely-toothed and bristle-tipped. Typically dull green on the upper-side, seedlings turning red in fall. Similar Species: Black Oak (Not shown), White Oak (Not shown)

Seedlings: Deciduous



Paper Birch

Simple, alternate leaves ovate or triangular with coarse, doubly-serrate teeth. Rounded, entire leaf base. Very shade intolerant, typically growing in open, disturbed areas and large canopy gaps. Lacking wintergreen odor/taste of Yellow Birch. Similar Species: Yellow Birch



American Elm

Simple, alternate leaves obovate-oblong with coarse doubly-serrate teeth that appear as a smaller tooth on top of a larger one. Often rough to the touch on the upper-side of the leaf, thick and firm. Leaf base is asymmetrical, though this may be harder to notice on very young seedlings. Similar Species: American



Black Cherry

Simple, alternate leaves narrowly oval to oblong-lanceolate or acuminate. Dark green and lustrous/shiny on upper-side of leaf, paler beneath with dense, reddish-brown pubescence along both sides of the midrib near the blade base. Finely serrate with incurved teeth. Petioles with small red glands near the blade base. Pin Cherry lacks the pubescence along the midrib.

Invasive Plants



Barberry, Japanese and common—1

An armed deciduous shrub in the barberry family growing 8 to 10 feet in height and 6 feet in width. The bark is gray having sharp spines at nodes and the inner wood is yellow. Spines are double- or triple- branched. The arched hanging branches have clusters of leaves that are small, toothed, ovate, alternate, dull green above and grayish below.



© 2002 Gary Fewless

Suzan Campbell, MNFI

Buckthorn, common or glossy— 2

Deciduous woody shrub or small tree that ranges from 3 to 7.5 m (10-25 ft) in height. Leaves: Simple, dark green leaves, with toothed margins and 3 to 5 pairs of prominent leaf veins, which curve as they approach the leaf tip. The leaves are alternate, but some may appear opposite. twigs often have thorns at their tips, between the terminal buds.



UGA0016241



UGA2307125

Bittersweet, Oriental—3

Leafy, deciduous, sprawling, twining vine. Stems. Vines are many-branched, light brown to gray in color, may be green. Surface of smaller branches dotted with tiny, lighter-colored bumps (lenticels). Leaves. Arranged alternately along the stem, leaves vary widely in shape and can be round, oblong or teardrop-shaped with finely toothed margins and taper-

Invasive Plants

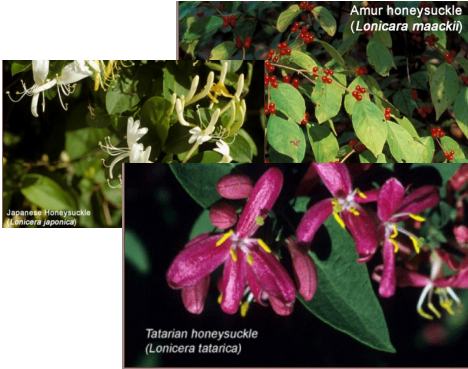

Honeysuckle: Bell, Japanese, Amur, Morrow, Tartarian—4

Egg-shaped leaves range from 1 to 3 inches in length and are arranged oppositely along stems. Begin flowering May to June and bear small (< 1 inch), very fragrant tubular flowers creamy white to pink to crimson. *L. morrowii* and *L. tatarica* produce ¼ inch red berries from mid-summer through early-fall; *L. maackii*'s dark-red berries don't ripen until late-fall; *L. japonica* produces dark-purple or black berries in the fall. Stems of all four are hollow.



Bill Johnson, James Miller (inset)

Multiflora Rose—5

Plant: multi-stemmed shrub, sometimes climbing vine, with arching stems and recurved thorns. Leaves: divided into five to eleven sharply toothed leaflets; **leaf stalks with fringed stipules** (paired wing-like structures). Flowers, fruits and seeds: clusters of showy, fragrant, white to pinkish, 1 in. wide flowers appear during May; small bright red fruits, or rose hips, develop during the summer and remain on the plant through the winter.

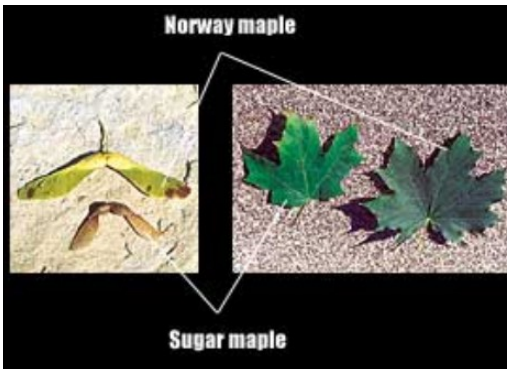

Norway Maple—6

Large deciduous tree, dense canopy, 60' high when mature. Similar to native sugar maple except: broken leaf emits milky sap, upright green flower clusters, widely spreading winged fruit, regularly grooved bark, fall color always yellow. Leaves: Opposite, five lobed, coarsely toothed, pointed. Flowers: Flat-topped upright cluster, yellow-

Invasive Plants



Autumn or Russian Olive—7

Russian Olive: Large deciduous shrub or small tree, up to 25' tall. Spreading branches form into a dense rounded crown. Thin bark comes off in narrow, elongate, fibrous strips. Twigs are very flexible and bear a terminal spine. Leaves: Alternate, distinctive silver-gray lance shaped. Flowers: Yellow spicy-fragrant flowers are borne either individually or in small clusters in the leaf axils, blooming in late spring.



Japanese Knotweed—8

Shrub-like, arching perennial herbaceous plant, over 10' high, reddish-brown stems, smooth, stout hollow and swollen at the joint where the leaf meets the stem. Leaves: Alternate broadly oval and pointed at the tip, about 6" long, 3 - 4" wide. Flowers: Greenish-white, branched clusters which grow from leaf axils, near the end of stems, blooming in late summer.



Garlic Mustard—9

Garlic odor produced when the leaves of the plant are crushed. Basal leaves of an immature plant dark-green, kidney shaped, round teeth along the edges; average size 6 to 10 cm in diameter. The petiole of first year plants are 1 to 5 cm long. In second year, alternating stem leaves become more triangular shaped, 1 to 5 cm long, sharper teeth. Leaf stalks of mature plants are hairy.

Invasive Plants

Privet—10



Privets are evergreen shrubs that may reach 30 feet in height. These shrubs have opposite, leathery, oblong leaves that terminate with a pointed tip. The stems are opposite or whorled and red tinged with many raised lenticels and the bark is light gray. Many small, white, and fragrant flowers appear in April to June. Drupes containing 1 to 4 seeds mature from July to March.

Tree of Heaven—11



Plant: deciduous tree reaching 70 ft. Twigs with smooth, pale gray bark, and twigs that are light chestnut brown, especially in the dormant season; leaves, stems and some flowers have a strong odor likened to cat urine or rotting peanuts or cashews. Leaves: alternate, large (1-4 ft. long), compound, with 11-25 smaller leaflets, each with one to several glandular teeth near the base. Flowers, fruits and seeds: large showy clusters of small yellowish-green flowers produced



Wild Chervil (cow parsnip) - 12



This is a biennial or short-lived perennial plant in the carrot family. It grows three to four feet on average but sometimes grows over six feet. Stems are hollow, branched and hairy. Fern-like leaves are nearly hairless and compound. Leaves form a basal rosette the first year. White flowers with five petals are produced in umbrella-like clusters that bloom from late May to early July during the plant's second year.

Invasive Plants



Burning Bush/Winged Euonymus—13

Deciduous shrub. Occasionally, four corky ridges appear along the length of young stems. Opposite, dark green leaves < 2 in long, smooth, rounded and tapered. Leaves turn bright crimson to purple in fall. Flowers inconspicuous, greenish yellow, 4 petals. Flowers develop in the spring and lay flat against the leaves. Fruit are reddish capsules that split to reveal orange fleshy seeds.



Goutweed—14

Most leaves basal, leafstalk attached to underground stem. Leaves divided into three groups of three leaflets. Leaflets toothed, sometimes irregularly lobed. "Wild" type foliage medium green; a commonly planted variegated form has bluish-green leaves with creamy white edges. Small, white, five-petaled flowers produced in mid-summer



Amur Maple—15

Amur maple is a small tree up to 20' high with a broad crown, but sometimes pruned as a hedge. Twigs are smooth and light colored. Leaves: Opposite, longer than wide and have three shallow lobes and double toothed edges, turning a brilliant red in fall. Flowers: Fragrant flowers appear in loose clusters with young leaves in May and June. Fruit: Numerous reddish, two-winged, inch long fruit mature in late summer.

Invasive Plants



Amur cork-tree—PHAM2

Outer bark is thick and corky, inner bark is bright yellow. Buds are red, under petiole. Leaves are pinnately compound, 10-15 inches long, 5-13 leaflets.



**Black swallow-wort—
CYLO11**

Perennial climbing vine, forms thick mats. Leaves are opposite, long, elliptical. Flowers are deep purple and fuzzy. Flowers give way to seed pods that are 1.5 to 3" in length.



**Creeping jenny, money-
wort—LYNU**

Grows from full sun to full shade. Leaves are round, up to an inch long, oppositely paired on the stem, with entire margins. Flowers are yellow, with 5 rounded yellow petals. Stems are hairless.

Invasive Plants



Kudzu—PUMO

Herbaceous, semi-woody vine. Climbs and encases trees. Vines and leaves are hairy. Reproductive structure is a hairy pod. Leaves are alternate, compound, 20cm long, with 3 oval to cordate leaflets at the end. Aromatic flowers.



Mile-a-minute weed— POPE10

Disturbed areas. Herbaceous vine, stem thin, green, barbed, turns brown and semi-woody. Leaves: 4-7cm, cordate, barbed underside. Reproductive structure surrounds stem, clumped, berry-like reproductive structures.



Narrowleaf bittercress— CAIM

Prefers forested floodplains. Forms rosette during first year with 3-11 leaflets that have rounded lobes, then usually becomes an erect stem the second year with 6-20 sharply toothed leaflets. Has seed pods.

Invasive Plants



Porcelain berry—AMBR7

Deciduous vine that climbs trees. Leaves are alternate, cordate, and have three to five palmate lobes. White flowers from June to August, then has grape-like berries.



Sycamore maple—ACPS

Grows in part to full sunlight, tolerant of a wide range of soils. Leaves are opposite, lobed, serrated, and 4 to 8 inches in length. Buds are imbricate and reddish brown in color. Growth form is spreading and rounded, and bark is scaly and peels.



Vermont Plot Coordinates

PlotID	Latitude, Longitude
FEMC001	44.240143, -72.526499
FEMC002	43.614956, -73.239388
HHSB05G07	44.471785, -73.180262
HHSC01K07	44.938719, -72.999441
HHSC12F02	43.745383, -73.09608
HHSF01A11	44.932395, -72.533667
HHSG01G10	44.932975, -72.377292
HHSG19A05	43.891018, -72.558339
HHSI09K10	44.082201, -72.151455
LBA1400A	43.105024, -73.083125
LBA1400B	43.143587, -73.035833
LBA2300A	43.132473, -72.976966
LBA2300B	43.119081, -73.041618
LBA2300C	43.054726, -73.045672
LEMP11	43.849144, -73.036758
LEMP12	43.887744, -72.894038
LEMP13	43.933983, -73.083944
LEMP14	44.093992, -73.020248
LEMP16	43.437375, -72.929233
LEMP17	43.411542, -72.931326
LEMP18	43.289216, -72.968564
LEMP20	42.871901, -73.024004
LEMP5	43.176283, -72.898624
MMBR1400	44.525735, -72.864691
MMBR2200	44.534433, -72.838757
MMBR3000	44.531113, -72.822399
MMBR3800A	44.522786, -72.816959
MMBR3800B	44.523627, -72.817302
MMRB1400A	44.50179, -72.780413
MMRB1400B	44.50207, -72.793261
MMRB2200A	44.492174, -72.799053
MMRB2200B	44.51261, -72.808512

PlotID	Latitude, Longitude
MMRB3000A	44.517553, -72.811413
MMRB3000B	44.517285, -72.812619
MMSB1400	44.505388, -72.842027
MMSB2200	44.506375, -72.831957
MMSB3000	44.516729, -72.821946
NAMP36	44.077074, -72.558466
NAMP39	44.172933, -72.294507
NAMP5	44.508412, -72.222242
VMC1063	43.909617, -72.854154
VMC1130	43.087253, -72.450634
VMC1235	43.97245, -73.051855
VMC244	42.914973, -73.137387
VMC245	44.334793, -72.901988
VMC495	44.764976, -72.588301
VMC593	44.865207, -71.716418
VMC812	43.774774, -72.512419
VMC919	44.099398, -73.043956

Massachusetts Plot Coordinates

PlotID	Latitude Longitude
MACFI0407	42.36365, -73.208259
MACFI0609	42.246631, -73.265054
MACFI0729	42.062758, -73.168395
MACFI0901	42.737318, -72.987539
MACFI1321	42.645568, -72.75149
MACFI1402	42.598867, -72.426836
MACFI1512	42.327898, -73.04076
MACFI1587	42.376919, -72.881932
MACFI1607	42.310855, -72.476088
MACFI1746	42.129668, -73.061034
MACFI1823	42.091148, -72.237281
MACFI2341	42.077475, -71.794131
MACFI2365	42.498286, -71.906331
MACFI2556	42.651595, -71.695224
MACFI2980	42.666103, -70.916688
MACFI3554	41.693796, -70.975782
MACFI3662	41.856711, -70.707339
MACFI3841	41.559864, -70.496311
MACFI5024	42.644316, -73.174476
MACFI5259	42.120847, -73.438458